



# VT Hackney

A company of VT Systems



## Model PL0773 Medium Rescue

**Hackney**

Sourcewell   
Formerly NJPA

Awarded Contract

Contract # 022818-VTH

PL-0773

Hackney Emergency Vehicles

NJPA - HACKNEY PL0773

Sales Rep:

Terms:

Drawing #:

Est. Delivery Date: / /

Customer PO #:

Penalty:

Customer #:

QPF #:

Exp. Date: 02/11/2018

Quote No: 10120-0002

BODY: XPL100 NJPA PL0773 RESCUE

08/17/2018

Page 1

PART NO	DESCRIPTION	QTY
== NJPA PL0773 RESCUE - ==		1
<b>CAB and CHASSIS</b>		<b>1</b>
10-02-0300	FREIGHTLINER M2-106 2-DOOR - CUMMINS ISL-330	1
10-19-0000	FLUID LEVEL DATA PLATE - VISIONMUX	1
10-19-1010	WELDON VEHICLE DATA RECORDER (VDR) - VISIONMUX - NFPA 1901-2009	1
10-19-1025	"MUST BE SEATED AND BELTED" - WARNING PLATE	1
10-19-1045	WARNING PLATE - VEHICLE SPECIFICATION DATA	1
10-19-1075	"DO NOT WEAR HELMET WHILE SEATED" - WARNING PLATE	1
10-99-1600	EXHAUST, VERTICAL STACK - OEM INSTALLED	1
11-16-0220	BATTERY CONDITIONER - PROGRESSIVE DYNAMICS	1
11-17-0015	SHOREPOWER- KUSSMAUL AUTO-EJECT - 15-AMP	1
11-31-5005	ENGINE COMP'T LIGHT - Centered Under Hood	1
12-00-1010	MUD FLAPS - RE-INSTALL CHASSIS OEM	1
12-10-1000	CAB STEP - RIGHT SIDE - 2-DR	1
12-11-1000	FUEL TANK COVER/STEP - FREIGHTLINER - 2-DR	1
12-11-1900	ULTRA-LOW SULFUR DIESEL FUEL ONLY LABEL	1
12-11-1950	DEF FLUID LABEL	1
12-57-0021	TIRE PRESSURE MONITORING - REALWHEELS AIRSECURE - 6-WHL	1
16-10-1500	TOW EYES - FRAME MOUNTED (PR)	1
<b>BODY and FRAME OPTIONS</b>		<b>1</b>
20-00-3000	FRAME MODIFICATION - LR/PL	1
20-02-0000	BODY CONSTRUCTION - HEAVY RESCUE	1
20-11-0110	BODY - PL-0773 - 7 COMP'T - 73"/48"	1
20-49-9000	OVERALL HEIGHT PLATE	1
20-61-0200	ROLLERS, STAINLESS STEEL ROLL-UP DOOR - ILOS - (Ea. Comp't Door)	7
20-71-0020	WHEELHOUSING SKIRT PANEL - PAINTED	1

PART NO	DESCRIPTION	QTY
20-71-0120	FRONT BODY PANEL - PAINTED	1
20-71-0320	FENDERETTES, STAINLESS STEEL (PR)	1
20-72-3000	ULTRA-LOW SULFUR DIESEL FUEL ONLY LABEL	1
20-72-3100	DEF FLUID LABEL	1
<b>EXTERIOR BODY OPTIONS</b>		<b>1</b>
22-21-0010	STONE GUARDS, FRT & REAR - D/P - (4) - up to 73"H	1
22-25-2000	BUMPER, REAR STEP BRIGHT TREAD PLATE	1
22-25-5500	SIGN - "DANGER - DO NOT RIDE ON REAR STEP"	1
22-33-1000	STEP, REAR WHEEL ALUMINUM STEP (PR)	1
22-40-0090	WHEEL CHOCK - ZICO COLLAPSIBLE TYPE (EA)	2
22-40-0100	HOLDER FOR WHEEL CHOCK - ZICO SQCH-44 (EA)	2
22-50-3005	LICENSE FRAME W/LIGHT-SURFACE MNT-CPI C30004	1
22-51-1000	MUD FLAPS, REAR (PR) BLACK RUBBER	1
<b>INTERIOR BODY OPTIONS</b>		<b>1</b>
23-11-0550	RECESSED ADJUSTABLE SHELF TRACK (EA)	7
23-11-2101	SHELF - EXTENDED FLOOR - PERMANENT (EA)	2
<b>EXTERIOR BODY OPTIONS</b>		<b>1</b>
<b>PAINT and GRAPHICS</b>		<b>1</b>
40-00-0011	PAINT BODY - MEDIUM RESCUE - ONE COLOR	1
41-00-0000	DO NOT RE-PAINT CAB	1
42-12-0000	TOUCH UP PAINT - ONE QUART	1
42-90-0500	COMPARTMENT WALLS/FLOORS COATING - MULTISPEC (ea. comp't)	7
42-99-0000	UNDERCOATING CAB, FRAME & BODY	1
43-20-2000	STRIPE, REFLECTIVE 4" PRICE PER FOOT REQS DWG	50
43-20-8025	CHEVRON STRIPE - REAR BODY W/NO REAR DOOR - HEAVY RESCUE	1
43-20-8120	REFLECTIVE STRIPING ACROSS FACE OF BUMPER	1
<b>12VDC ELECTRICAL SYSTEM</b>		<b>1</b>
50-00-0410	ELECTRICAL SYSTEM - V-MUX MULTIPLEX	1
50-00-2110	PANAVISE SWIVEL MOUNTING BRACKET	1
50-05-0000	AMP DRAW REPORT - NFPA 1901, Section 9-15	1
50-06-1110	SAFETY INTERLOCK SYSTEM - MED/HD CHASSIS	1
50-10-0100	CAB CONSOLE - FLOOR MOUNT - INTERNATIONAL/FREIGHTLINER - VISIONMUX/V-MUX	1
50-20-0200	BRACKET- HAVIS-SHIELDS SIREN FOR WHELEN 295-Series	1
50-40-0110	CLEARANCE LIGHTS, LED & REFLECTORS W/CENTER REAR THIRD BRAKE	1
50-50-0200	TAIL LIGHT ASSY - LED STOP/TURN/BACKUP with CHROME BEZELS	1
50-50-6000	JAKE BRAKE LIGHT ACTIVATION	1
51-19-0110	GROUND LIGHTS - TECNIQ LED - UNDERBODY MOUNTED (EA)	5
51-19-0130	GROUND LIGHTS ACTIVATED BY TURN SIGNALS /REVERSE	1
51-50-1810	COMPARTMENT LIGHTS - LED STRIP - 24" RECESSED	4
51-50-1943	COMPARTMENT LIGHTS - LED STRIP - 43" SURFACE	3
51-55-1001	COMP'T OPEN WARNING & AUTO ACTIVATION - VISIONMUX	1
51-55-2000	COMP'T OPEN WARNING BUZZER	1
51-56-0100	COMP'T OPEN WARNING LIGHT - LED	1
<b>NFPA 1901 WARNING LIGHTS</b>		<b>1</b>

PART NO	DESCRIPTION	QTY
<b>UPPER ZONE A - FRONT CAB WARNING LIGHTS</b>		<b>1</b>
54-01-1556	WHELEN JUSTICE JE2NFPA - 56" LIGHT BAR - V-END Configuration	1
54-01-9902	BRACKET, LIGHTBAR CAB ROOF MOUNTING -Whelen	1
<b>LOWER ZONE A - FRONT CAB WARNING LIGHTS</b>		<b>1</b>
54-10-07RC	WHELEN C7LRC RED SURFACEMAX - CLEAR LENS W/C7FC CHROMED BEZEL (ea)	2
54-15-5000	HEADLIGHT WIG-WAG PATTERN - V-MUX	1
<b>LOWER ZONE B/D - CAB INTERSECTION WARNING LIGHTS</b>		<b>1</b>
54-20-05RC	WHELEN 50R02ZCR RED SUPER-LED - CLEAR LENS W/5TSMAC CHROME BEZEL (ea)	2
<b>LOWER ZONE B/D - SIDE BODY WARNING LIGHTS</b>		<b>1</b>
54-21-06RC	WHELEN C6LRC RED SURFACEMAX - CLEAR LENS W/C6FC CHROMED BEZEL (ea)	4
<b>LOWER ZONE C - REAR BODY WARNING LIGHTS</b>		<b>1</b>
54-25-06RC	WHELEN C6LRC RED SURFACEMAX - CLEAR LENS W/C6FC CHROMED BEZEL (ea)	2
<b>UPPER ZONE B/D - SIDE BODY WARNING LIGHTS</b>		<b>1</b>
54-30-09RC	WHELEN C9LRC RED SURFACEMAX - CLEAR LENS W/C9FC CHROMED BEZEL (ea)	4
<b>UPPER ZONE C - REAR BODY WARNING LIGHTS</b>		<b>1</b>
54-31-09RC	WHELEN C9LRC RED SURFACEMAX - CLEAR LENS W/C9FC CHROMED BEZEL (ea)	2
54-99-0000	NFPA LIGHTING CERTIFICATION	1
<b>AUDIBLE WARNING DEVICES</b>		<b>1</b>
55-22-1000	SIREN - WHELEN ELECTRONIC - 295SLSA1	1
55-30-1000	HORN/SIREN SWITCH	1
55-41-4020	SPEAKER, SIREN - FREIGHTLINER M2 - THROUGH-THE-BUMPER (EA)	1
58-50-1000	12VDC POWER STRIP - (6) TERMINALS - CAB	1
58-80-1000	BACK-UP ALARM - FEDERAL 210333	1
58-82-0000	REARVIEW COLOR CAMERA W/NIGHTVISION & MONITOR - Visionmux	1
59-59-0000	ANTENNA COAXIAL W/CONNECTOR - MOTOROLA 17'	1
<b>120/240VAC ELECTRICAL SYSTEM</b>		<b>1</b>
<b>AIR SYSTEMS</b>		<b>1</b>
89-99-9600	DOT SAFETY KIT	1
<b>ADMINISTRATIVE - FIXED</b>		<b>1</b>
98-01-1000	MANUAL, HACKNEY OWNERS W/SCHEMATICS	1
98-10-1500	PRE-DELIVERY CLEAN-UP - CAB & BODY	1
98-11-1000	FUEL TANK FULL AT FACTORY DELIVERY (up to 50-gallon tank)	1
99-99-9998	TEST DRIVE & INSURANCE REQUIREMENTS	1
99-99-9999	SHOP ORDER APPROVAL	1

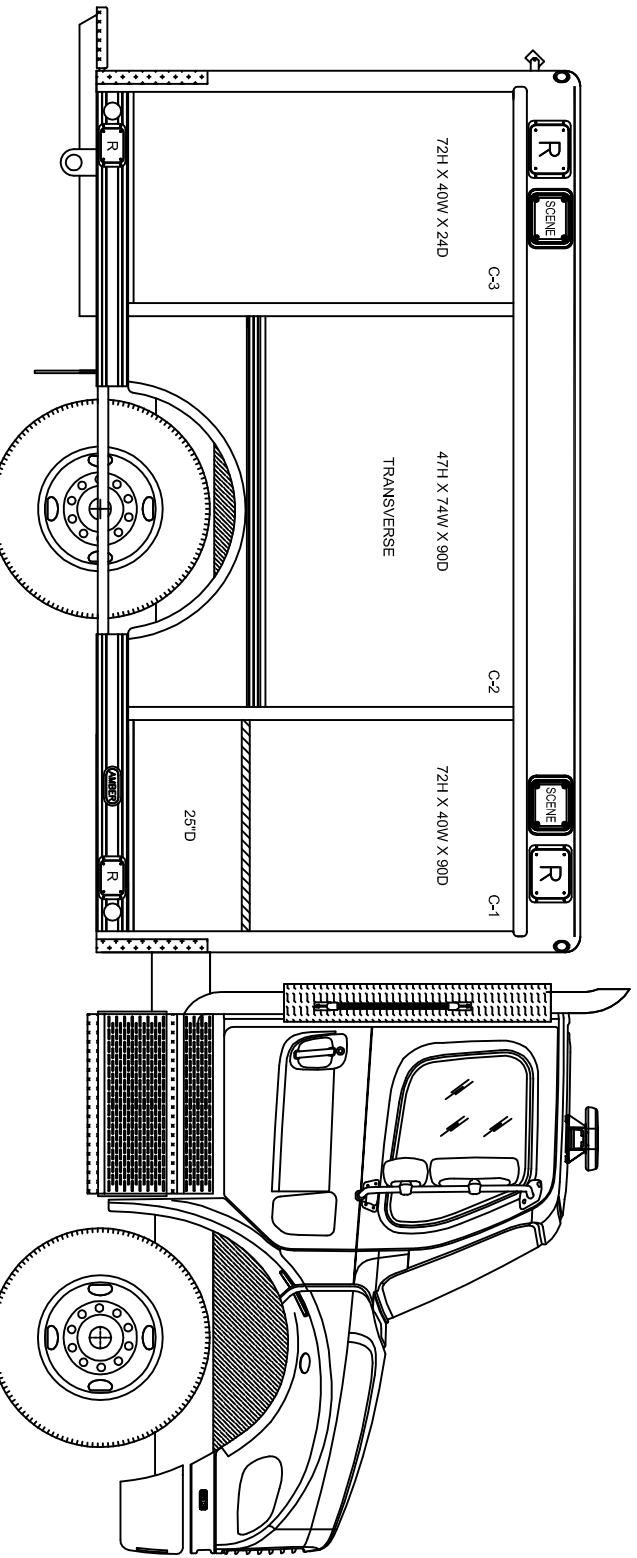



CURBSIDE EXTERIOR

THIS PRINT AND ALL RIGHTS TO THE DESIGN AND DETAIL THEREON ARE THE PROPERTY OF VTHACKNEY AND IS LOANED TO THE REPERENT SUBJECT TO RETURN UPON DEMAND. ITS USE FOR ANY OTHER PURPOSES IS STRICTLY PROHIBITED. ANY OR SUBMITTED TO OUTSIDE PARTIES FOR USE OR EVALUATION WITHOUT THE WRITTEN PERMISSION OF VTHACKNEY IS STRICTLY PROHIBITED. © 2015 VTHACKNEY A COMPANY OF VT SYSTEMS

© 2015 VTHACKNEY INC.

NOTE: ESTIMATED DIMENSIONS, MEASUREMENTS DEPEND ON CHASSIS, TIRES, SPRINGS, AND LOADING.

 <b>VT Hackney</b> A Company of VT Systems WASHINGTON, NC 27889-0880		 	
DRAWN BY: EES DATE: 02/01/18 SHEET: 1 OF 3 MODEL: PL-0773	CUSTOM DESIGN FOR: <b>NJPA</b> <b>CONTRACT #</b>		SCALE: 20 REV: -

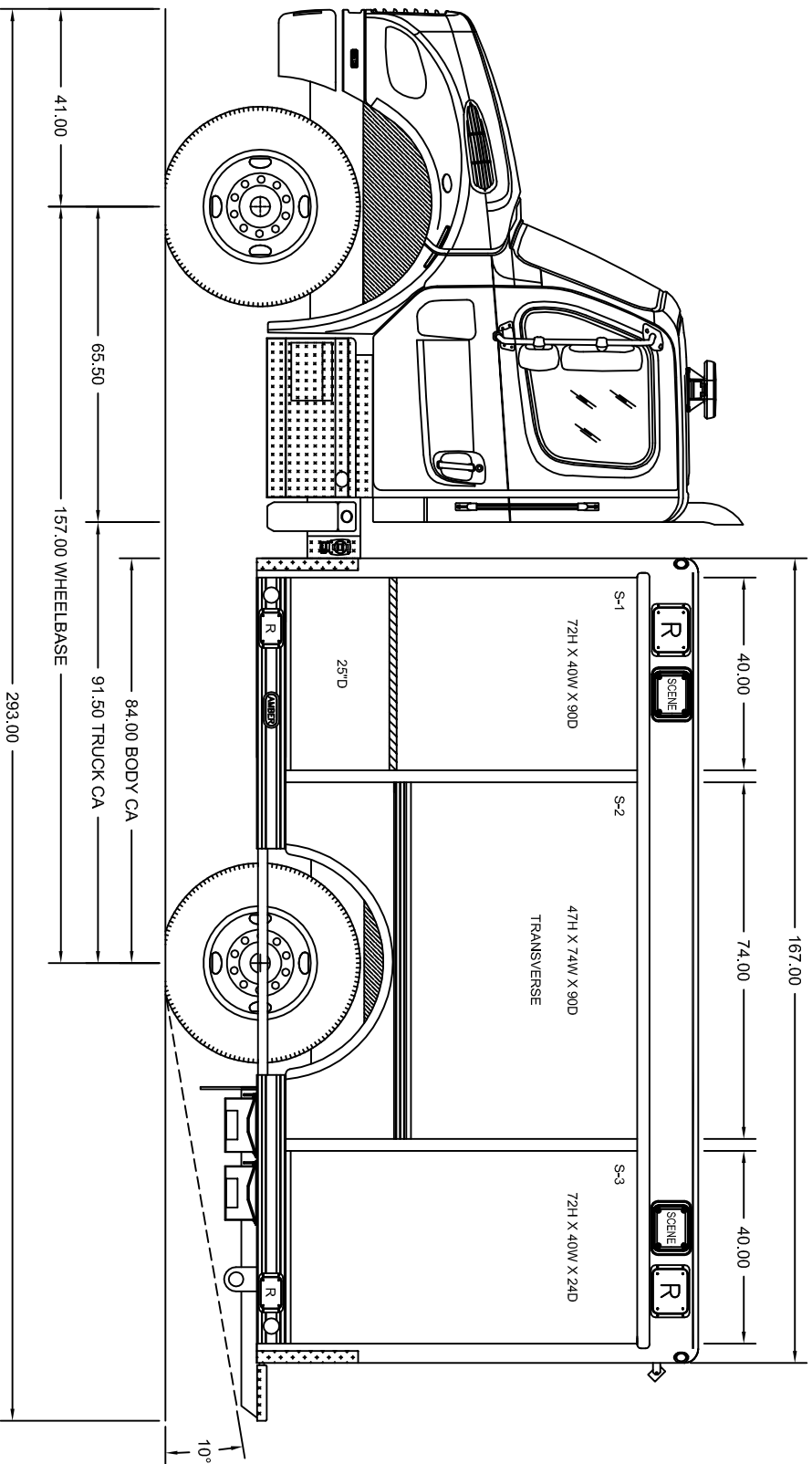

STREETSIDE EXTERIOR

THIS PRINT AND ALL RIGHTS TO THE DESIGN AND DETAIL THEREON ARE THE PROPERTY OF VTHACKNEY AND IS LOANED TO THE RECIPIENT SUBJECT TO RETURN UPON DEMAND. ITS USE IS LIMITED TO THE PROJECT AND NOT TO BE REPRODUCED OR SUBMITTED TO OUTSIDE PARTIES FOR USE OR EVALUATION. COPYRIGHT 2015 VTHACKNEY A COMPANY OF VT SYSTEMS

 A company of VT Systems WASHINGTON, NC 27889-0880		 	
DRAWN BY: EES DATE: 02/01/18 SHEET: 2 OF 3 MODEL: PL-0773	CUSTOM DESIGN FOR: NUPA CONTRACT #	SCALE: 20	REV: -

© 2015 VTHACKNEY INC.  
 NOTE: ESTIMATED DIMENSIONS,  
 MEASUREMENTS DEPEND ON CHASSIS,  
 TIRES, SPRINGS, AND LOADING.

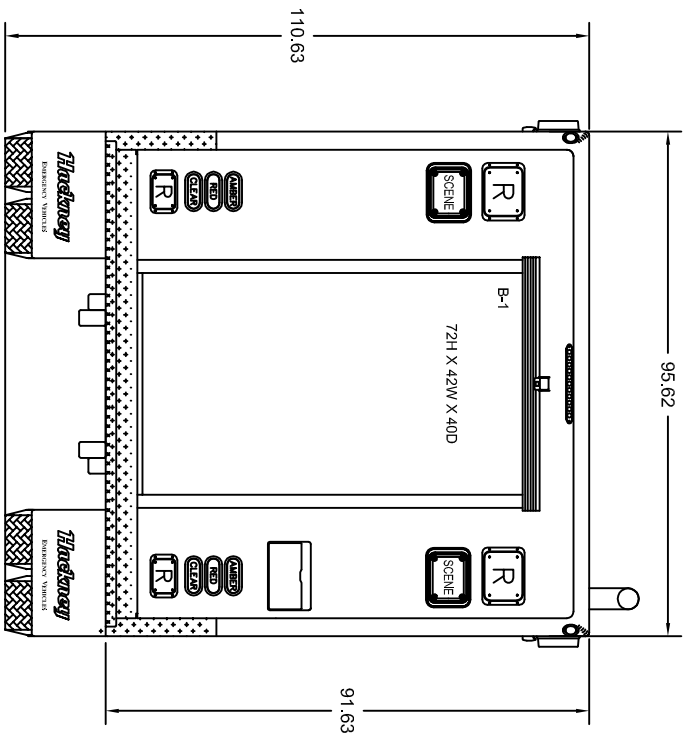

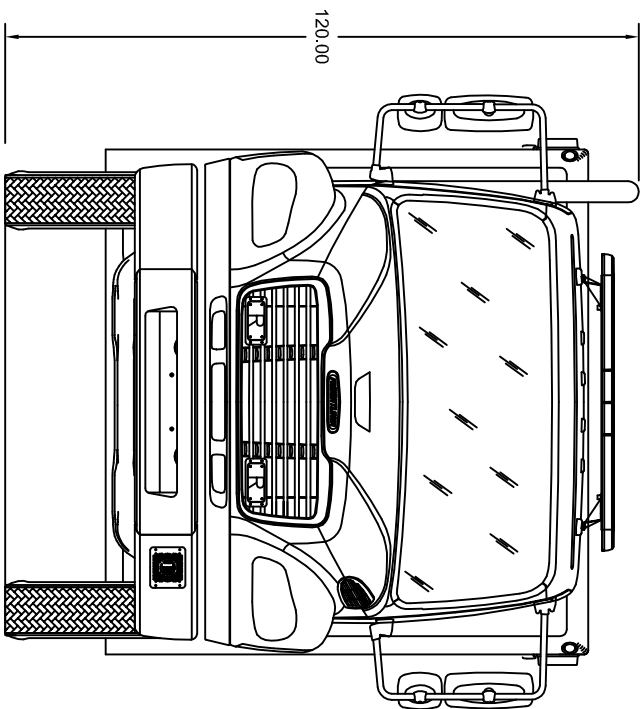

REAR VIEW



FRONT VIEW

THIS PRINT AND ALL RIGHTS TO THE DESIGN AND DETAIL THEREON ARE THE PROPERTY OF VTHACKNEY AND IS LOANED TO THE REQUESTOR. IT IS TO BE USED ONLY FOR THE PURPOSES SPECIFIED AND NOT BE REPRODUCED, COPIED, OR TRANSMITTED IN ANY FORM OR BY ANY MEANS, ELECTRONIC OR MECHANICAL, INCLUDING PHOTOCOPYING, RECORDING, OR BY ANY INFORMATION STORAGE AND RETRIEVAL SYSTEM, WITHOUT THE WRITTEN PERMISSION OF VTHACKNEY. FOR SUBMITTAL TO OUTSIDE PARTIES FOR USE OR EVALUATION, CONTACT 2015 VTHACKNEY A COMPANY OF VT SYSTEMS.

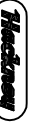
© 2015 VTHACKNEY INC.  
 NOTE: ESTIMATED DIMENSIONS, MEASUREMENTS DEPEND ON CHASSIS, TIRES, SPRINGS, AND LOADING.

 <b>VT Hackney</b> A company of VT Systems WASHINGTON, NC 27889-0880		 	
DRAWN BY: EES DATE: 02/01/18 SHEET: 3 OF 3	CUSTOM DESIGN FOR: NUPA CONTRACT #	SCALE: 20	REV: -
MODEL: PL-0773			